



Product designation	Miniature circuit breaker (MCB)
Product type designation	P1 MB
Number of poles	3P
Number of DIN modules	3
Compliance	IEC / UL1077

Electrical features

Rated insulation voltage U_i IEC/EN	V	440
Rated impulse withstand voltage U_{imp}	kV	4
Rated operational voltage AC (IEC)	VAC	230/400
Rated frequency	Hz	50/60
Rated current (I_n)	A	25
Tripping curve		B
Short circuit rating (IEC)	kA	10
Electrical life	cycles	10000
Power dissipation per pole max	W	2.13

Ambient conditions

Operating temperature	min	°C	-40
	max	°C	+70
Storage temperature	min	°C	-40
	max	°C	+80
Max altitude		m	2000

Mechanical features

Operating position	normal	Vertical plan		
Fixing		35mm DIN rail		
Tightening torque for terminals	min	Nm	1.8	
	max	Nm	2	
	min	Ibin	16	
	max	Ibin	17.7	
Terminals tool		Pz 2		
Conductor section	IEC	min	mm ²	1
		max	mm ²	35
	AWG/Kcmil	min		14
		max		6
Mechanical life		cycles	20000	
Weight		g	345	
Frontal IP degree			IP20	
Pollution degree			2	

Dimensions

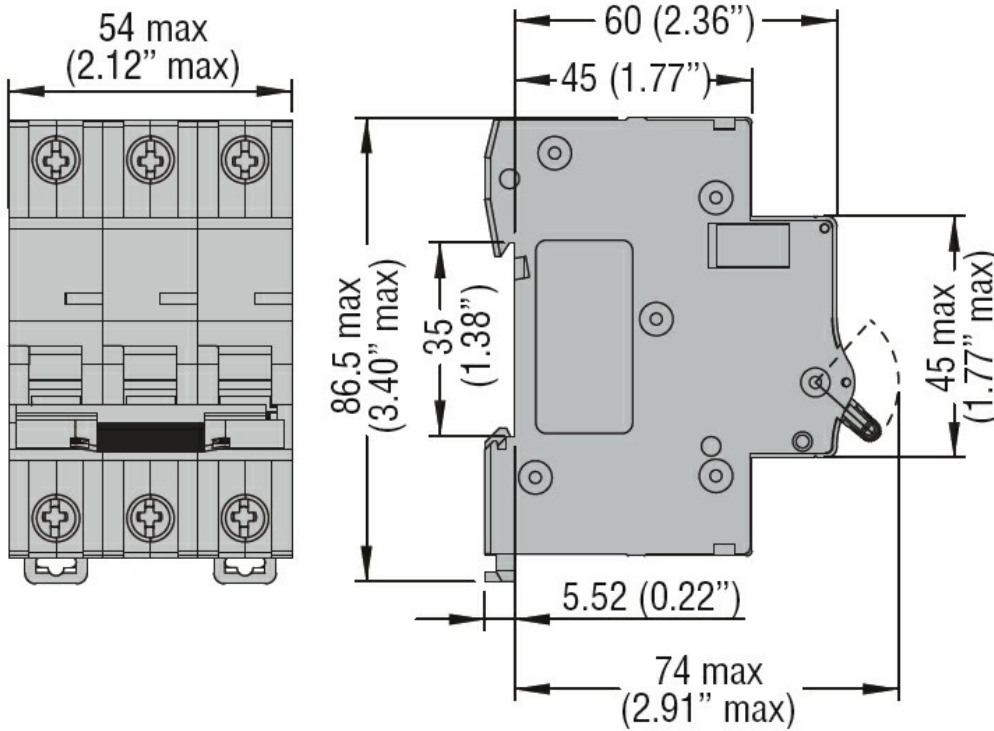

Wiring diagrams



Certifications and compliance

Compliance

CSA C22.2 n°235. UR "UL Recognized" per Canada e USA.
 IEC/EN 60898-1
 IEC/EN 60947-2
 UL 1077

Certifications

cURus
 EAC
 TÜV-Rheinland

ETIM classification

ETIM 8.0

EC000042 -
 Miniature circuit
 breaker (MCB)